

RM/92000/M, Kurzhubzylinder Mit Magnetkolben, doppelwirkend



- > Ø 12 ... 100 mm
- > Um zwei Drittel kleiner als vergleichbare ISO/VDMA Modelle
- > Dichtungen für geringe Reibung und lange Lebensdauer
- > Korrosionsgeschützte Materialien
- > Standard mit Magnetkolben



Technische Merkmale

Betriebsmedium:

Gefilterte, geölte oder ungeölte Druckluft

Wirkungsweise:

Doppeltwirkend, mit Magnetkolben, ohne Endlagendämpfung

Betriebsdruck:

1 ... 10 bar (14 ... 145 psi)

Zylinderdurchmesser:

12, 16, 20, 25, 32, 40, 50, 63, 80, 100 mm

Standardhublängen:

Siehe unten

Sonderhublängen:

200 mm Ø 16 ... 25 mm
250 mm Ø 32 & 40 mm
300 mm Ø 50 ... 100 mm

Gerätetemperatur:

-5° ... +80°C (+23° ... +176°F)

Um das Einfrieren der beweglichen

Teile zu vermeiden, muss

die Druckluft unter +2°C (+35°F) frei von Feuchtigkeit sein.

Material:

Zylinderrohr & end caps:

Aluminium eloxiert

Kolbenstange: Edelstahl

(Ø 12 ... 40 mm austenitisch,

Ø 50 ... 100 mm ferritisch)

Dichtungen: PUR und/oder NBR



Technische Daten

Zylinder Ø (mm)	12	16	20	25	32	40	50	63	80	100
Anschluss	M 5	M 5	M 5	M 5	G 1/8	G 1/8	G 1/8	G 1/4	G 1/4	G 1/4
Kolbenstangen Ø (mm)	6	8	10	12	16	16	20	20	25	25
Kolbenstangengewinde	M 3	M 4	M 5	M 6	M 8	M 8	M 10	M 12	M 16	M 16
Theoretische Kraft bei 6 bar ausfahrend (N)	68	121	188	295	483	754	1178	1870	3016	4712
Theoretische Kraft bei 6 bar einfahrend (N)	51	90	141	227	362	633	990	1682	2721	4418
Luftverbrauch bei 6 bar einfahrend (l/cm)	0,008	0,014	0,022	0,035	0,056	0,088	0,138	0,218	0,352	0,55
Luftverbrauch bei 6 bar ausfahrend (l/cm)	0,007	0,011	0,017	0,027	0,042	0,074	0,116	0,196	0,318	0,515

Standardhublängen

Zylinder Ø (mm)	Hublänge (mm)										
	5	10	15	20	25	30	40	50	60	80	100
12	•	•	•	•	•	•	–	–	–	–	–
16	•	•	•	•	•	•	–	–	–	–	–
20	•	•	•	•	•	•	•	•	–	–	–
25	•	•	•	•	•	•	•	•	–	–	–
32	•	•	•	•	•	•	•	•	•	•	–
40	•	•	•	•	•	•	•	•	•	•	–
50	•	•	•	•	•	•	•	•	•	•	•
63	•	•	•	•	•	•	•	•	•	•	•
80	–	–	•	•	•	•	•	•	•	•	•
100	–	–	•	•	•	•	•	•	•	•	•

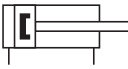
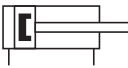
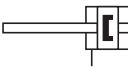
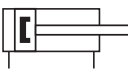
Alternative Ausführungen

Symbol	Typ mit Magnetkolben	Beschreibung	Seite
	RM/92000/M TRM/92000/M	Standardzylinder Hochtemperaturausführung: 150°C max. (nur für Ø 32 ... 100 mm)	4
	RM/92000/MU	Zylinder mit verlängerter Kolbenstange (Verlängerung bis zu 100 mm)	4
	RM/92000/JM	Zylinder mit durchgehender Kolbenstange Sonderhublängen (minimal): 5 mm = Ø 16 ... 40 mm, 10 mm = Ø 50 & 100 mm	6
	RM/92000/N2	Zylinder intern verdrehgesichert nur für Ø 16 ... 100 mm	6
	RM/92000/N4	Zylinder extern verdrehgesichert, nur für Ø 16 ... 100 mm Sonderhublängen (minimal): 50 mm = Ø 16 mm, 80 mm = Ø 20 & 25 mm 100 mm = Ø 32 ... 100 mm	6

Typenschlüssel

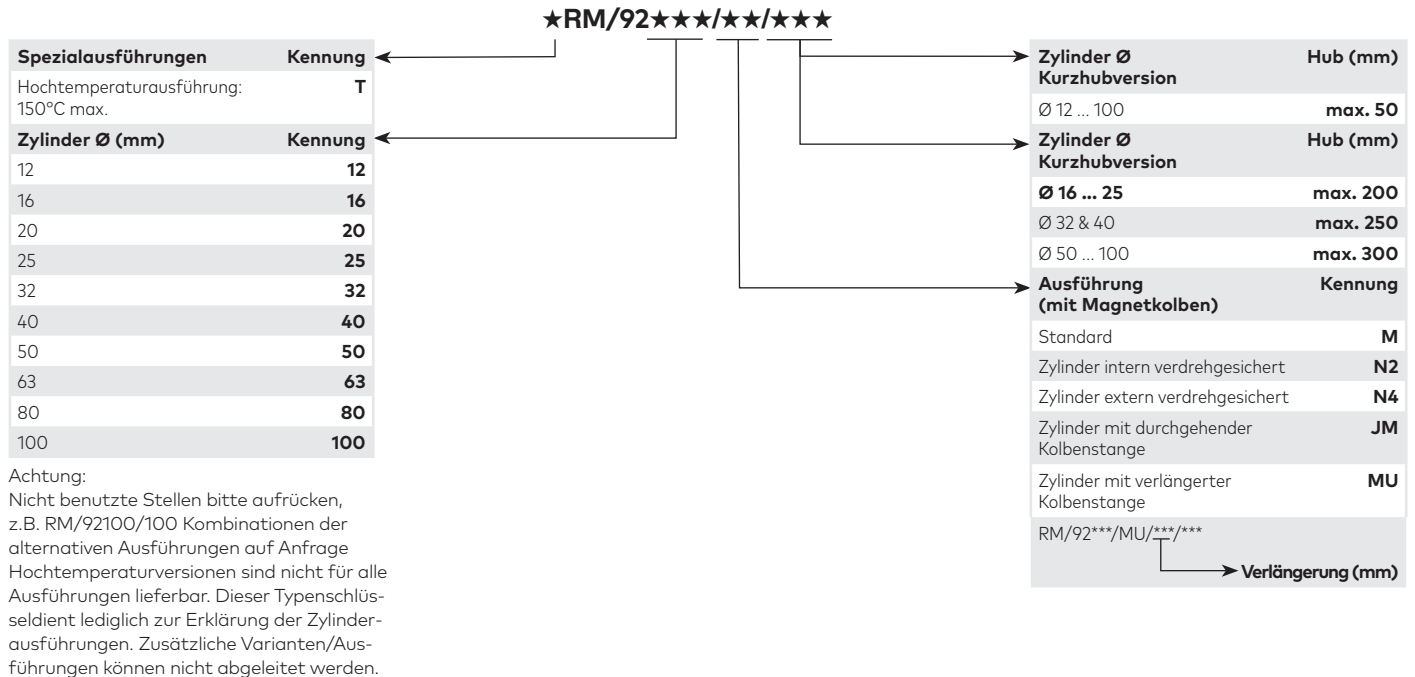

Befestigungselemente

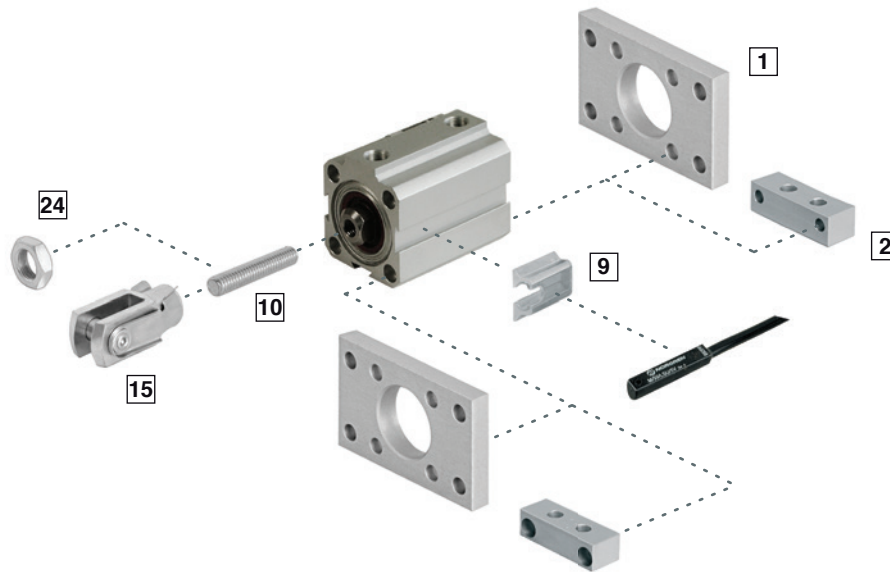

Typ	B, G	C	F	N	Bolzen	Adapter	Anbausatz
							
Ø	1 Seite 6	2 Seite 6	15 Seite 6	24 Seite 6	10 Seite 6	10 & 24 Seite 6	Seite 7
12	QM/90012/22	QM/90012/21	QM/57008/25	M/P1500/111	M/P1710/18	–	QM/92012/55
16	QM/90016/22	QM/90016/21	QM/8010/25	M/P1501/80	M/P1710/19	–	QM/92016/55
20	QM/90020/22	QM/90020/21	QM/92020/25	M/P1501/109	M/P1710/20	–	QM/92020/55
25	QM/90025/22	QM/90025/21	QM/57016/25	M/P1501/79	M/P1710/21	–	QM/92025/55
32	QM/90032/22	QM/90032/21	QM/57020/25	M/P1501/60	M/P1710/22	–	QM/92032/55
40	QM/90040/22	QM/90040/21	QM/57020/25	M/P1501/60	M/P1710/22	–	QM/92040/55
50	QM/90050/22	QM/90050/21	QM/57025/25	–	–	M/P71470/1	QM/92050/55
63	QM/90063/22	QM/90063/21	QM/57040/25	–	–	M/P71470/2	QM/92063/55
80	QM/90080/22	QM/90080/21	QM/57063/25	–	–	M/P71470/3	QM/92080/55
100	QM/90100/22	QM/90100/21	QM/57063/25	–	–	M/P71470/3	QM/92100/55

* Für die Montage der F-Befestigung bei Zylinder mit Innengewinde.

Zubehör

Typ	Magnetschalter	Befestigungselement für Schalter
		
Ø	Seite 8 & 9	9
All		M/P72487

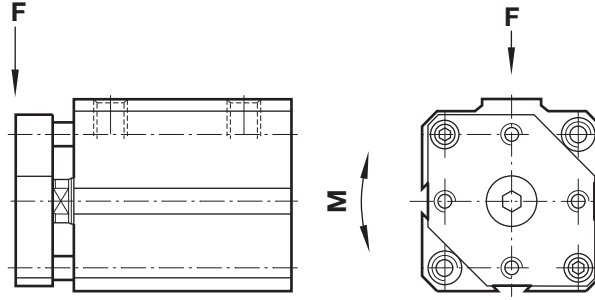
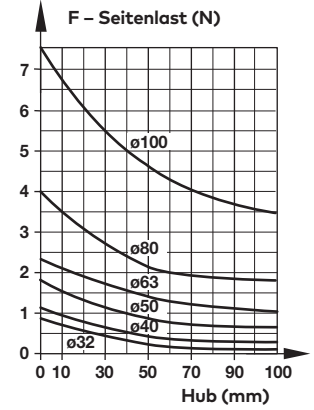
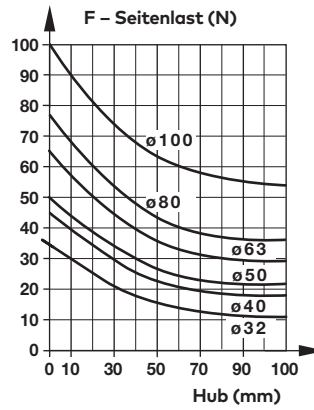
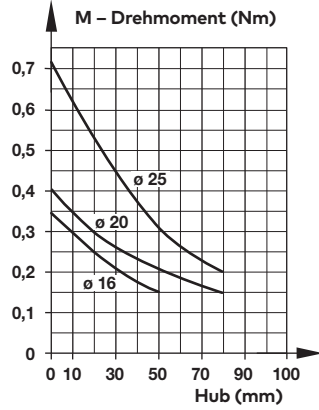
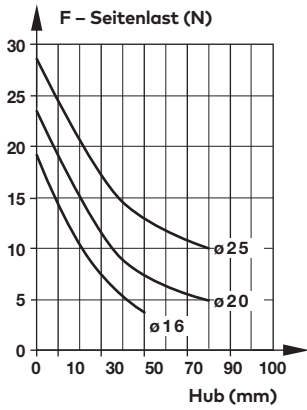
RM/92000/N4 – Zylinder extern verdrehgesichert
Zulässige Last und Drehmoment

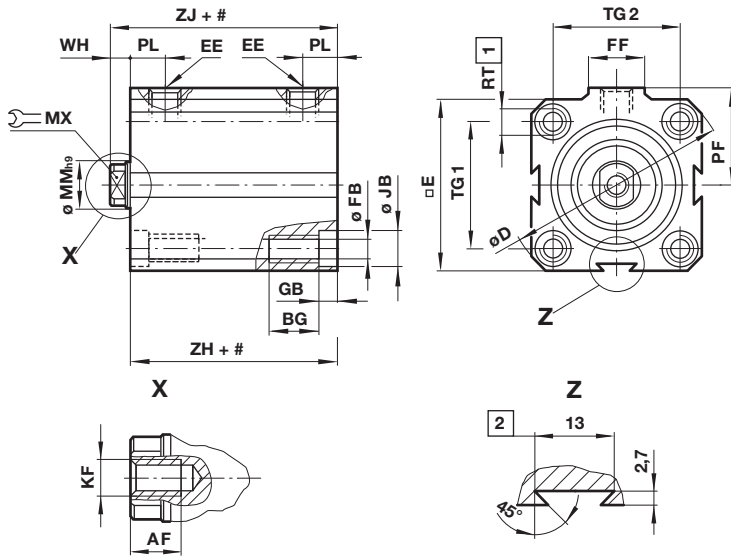
Zulässige Last und Drehmoment

Abmessungen
RM/92000/M – Standardzylinder

 Abmessungen in mm
 Projection/First angle

Hub

- 1] Keine bodenseitige Gewindebohrungen bei Hublängen unter:
 Ø 25 und 32 mm: 5 mm,
 Ø 40 und 63 mm: 15 mm (.../N2: 5 mm),
 Ø 50 und 80 mm: 10 mm, Ø 100 mm: 25 mm (.../N2: 15 mm).
- 2] Achtung: Schwabenschwanznut gegenüber der Anschlußseite entfällt bei Zylinder Ø 12 ... 20 mm.

Ø	AF	BG	Ø D	□ E	EE	Ø FB	FF	GB	Ø JB	KF	Ø MM h9	MX	PF	PL	RT	TG 1 2	WH	ZH *1)	ZJ *1)	bei 0 mm	per 5 mm	Typ	
12	6	9	32,5	25	M 5	3,3	10	3,5	6	M 3	6	5	15	7	M 4	17	13	4,5	24	28,5	0,06 kg	0,04 kg	RM/92012/M/*
16	7	9	36,5	28	M 5	3,3	10	3,5	6	M 4	8	6	17	7,5	M 4	20	20	5,5	24,5	30	0,08 kg	0,04 kg	RM/92016/M/*
20	8	9	41,5	32	M 5	3,3	10	3,5	6	M 5	10	8	19,5	7,5	M 4	23	23	6	26	32	0,10 kg	0,06 kg	RM/92020/M/*
25	9	12	48	37	M 5	4,2	10	4,5	7,5	M 6	12	10	22	8	M 5	27	27	6,5	28,5	35	0,15 kg	0,07 kg	RM/92025/M/*
32	12	12	58	45	G1/8	4,2	18	4,5	7,5	M 8	16	13	27,5	9	M 5	33	33	6,5	29	35	0,25 kg	0,12 kg	RM/92032/M/*
40	12	16	71,5	55	G1/8	6,8	18	6,5	10,5	M 8	16	13	31,5	10	M 8	41	41	6,5	31,5	38	0,38 kg	0,15 kg	RM/92040/M/*
50	14	16	81	63	G1/8	6,8	18	6,5	10,5	M 10	20	17	37	10,5	M 8	48	48	8	35	43	0,45 kg	0,18 kg	RM/92050/M/*
63	16	20	104	80	G1/4	8,5	22	8,5	13,5	M 12	20	17	48	13	M 10	61	61	8	42,5	50,5	0,82 kg	0,26 kg	RM/92063/M/*
80	22	20	120	94	G1/4	8,5	22	8,5	13,5	M 16	25	22	57	14,5	M 10	73	73	9	47	56	1,20 kg	0,33 kg	RM/92080/M/*
100	22	25	148,5	116,5	G1/4	10,2	22	10,5	16,5	M 16	25	22	67	16	M 12	90,5	90,5	10	48,5	58,5	1,83 kg	0,42 kg	RM/92100/M/*

* Bitte Hublänge einfügen.

*1) Plus 10 mm für Hublänge > 50 mm

Zylinderausführungen RM/92000/JM – Zylinder mit durchgehender Kolbenstange

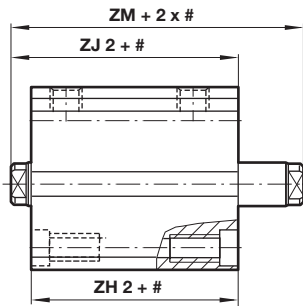

Hub

RM/92000/N2 – Zylinder intern verdrehgesichert

Abmessungen in mm
Projection/First angle

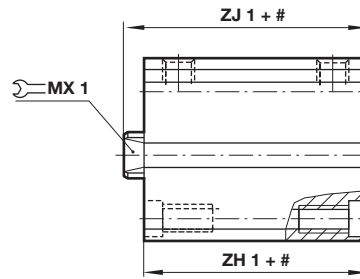

Hub

Ø	ZH2	ZJ2	ZM	Typ
16	29,5	35	41	RM/92016/JM/*
20	31,5	37,5	44	RM/92020/JM/*
25	34,5	41	48	RM/92025/JM/*
32	36,5	43	50	RM/92032/JM/*
40	39,5	46	53	RM/92040/JM/*
50	42	50	59	RM/92050/JM/*
63	52	60	69	RM/92063/JM/*
80	56	65	74	RM/92080/JM/*
100	58	68	78	RM/92100/JM/*

* Bitte Hublänge einfügen.

Ø	MX1	ZH1	ZJ1	Drehmoment	Typ
16	6	34,5	40	0,15 Nm (max.)	RM/92016/N2/*
20	8	36	42	0,25 Nm (max.)	RM/92020/N2/*
25	10	38	45	0,4 Nm (max.)	RM/92025/N2/*
32	13	39	45,5	0,75 Nm (max.)	RM/92032/N2/*
40	13	41,5	48	0,75 Nm (max.)	RM/92040/N2/*
50	16	45	53	1,5 Nm (max.)	RM/92050/N2/*
63	16	52,5	60,5	1,5 Nm (max.)	RM/92063/N2/*
80	21	57	66	2,5 Nm (max.)	RM/92080/N2/*
100	21	58,5	68,5	2,5 Nm (max.)	RM/92100/N2/*

* Bitte Hublänge einfügen.

RM/92000/N4 – Zylinder extern verdrehgesichert

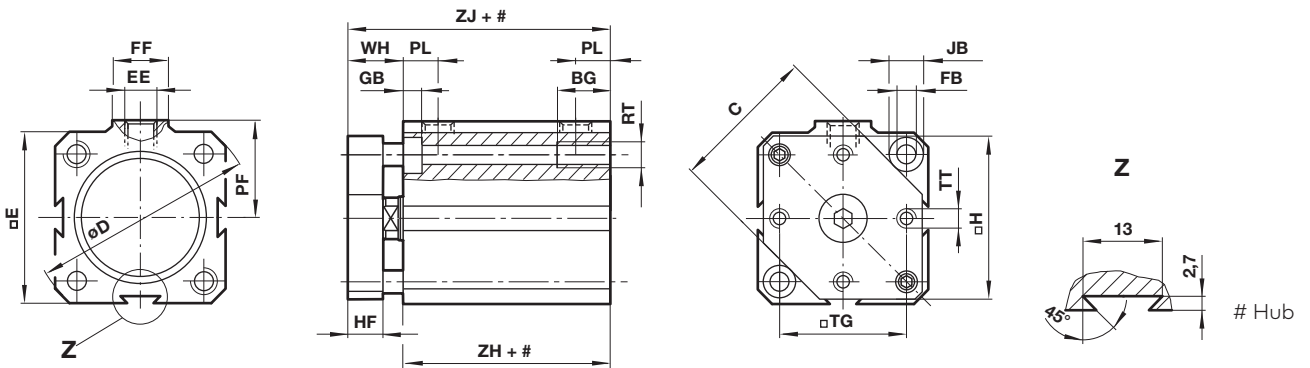

Ø	BG	C	ØD	qE	EE	ØFB	FF	GB	qH	HF	ØJB	PF	PL	RT	qTG	TT	WH	ZH *1)	ZJ *1)	bei 0 mm	per 5 mm	Typ
16	9	21	36,5	28	M5	3,3	10	3,5	26,5	6	6	17	7,5	M4	20	M3	11,5	24,5	36	0,110 kg	0,050 kg	RM/92016/N4/*
20	9	25	41,5	32	M5	3,3	10	3,5	30	8	6	19,5	7,5	M4	23	M3	14	26	40	0,130 kg	0,070 kg	RM/92020/N4/*
25	12	29,5	48	37	M5	4,2	10	4,5	35	8	7,5	22	8	M5	27	M4	14,5	28,5	43	0,170 kg	0,100 kg	RM/92025/N4/*
32	12	38	58	45	G1/8	4,2	18	4,5	43	10	7,5	27,5	9	M5	33	M4	16,5	29	45,5	0,280 kg	0,130 kg	RM/92032/N4/*
40	16	46,5	71,5	55	G1/8	6,8	18	6,5	52	10	10,5	31,5	10	M8	41	M5	16,5	31,5	48	0,440 kg	0,150 kg	RM/92040/N4/*
50	16	56,5	81	63	G1/8	6,8	18	6,5	60	12	10,5	37	10,5	M8	48	M6	20	35	55	0,500 kg	0,200 kg	RM/92050/N4/*
63	20	71	104	80	G1/4	8,5	22	8,5	76	12	13,5	48	13	M10	61	M8	20	42,5	62,5	0,900 kg	0,300 kg	RM/92063/N4/*
80	20	89	120	94	G1/4	8,5	22	8,5	90	16	13,5	57	14,5	M10	73	M10	25	47	72	1,350 kg	0,350 kg	RM/92080/N4/*
100	25	110	148,5	116,5	G1/4	10,2	22	10,5	113	20	16,5	67	16	M12	90,5	M13	30	48,5	78,5	2,200 kg	0,600 kg	RM/92100/N4/*

* Bitte Hublänge einfügen.

*1) Plus 10 mm für Hublänge > 50 mm

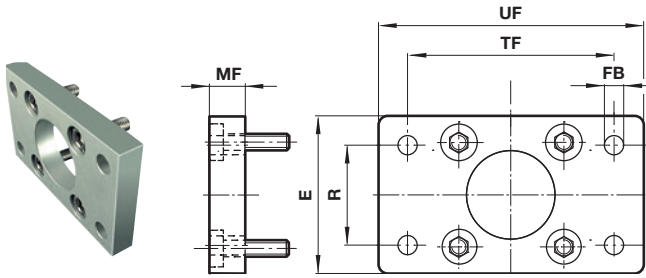
Befestigungselemente
Bodenflansch B, Kopfflansch G

Ø	E	R	Ø FB	MF	TF	UF	kg	Typ (B,G)
12	26	18	3,5	5	38	46	0,02	QM/90012/22
16	30	22	3,5	5	42	50	0,02	QM/90016/22
20	33	25	3,5	5	48	56	0,02	QM/90020/22
25	38	28	4,5	6,5	54	64	0,04	QM/90025/22
32	46	36	4,5	6,5	66	76	0,06	QM/90032/22
40	57	43	6,5	9,5	78	92	0,15	QM/90040/22
50	64	50	6,5	9,5	90	104	0,17	QM/90050/22
63	81	63	9,5	12,5	110	128	0,33	QM/90063/22
80	95	77	8,5	12,5	128	146	0,41	QM/90080/22
100	118	98	11	12,5	156	176	0,72	QM/90100/22

Fußbefestigung C, ISO 6432

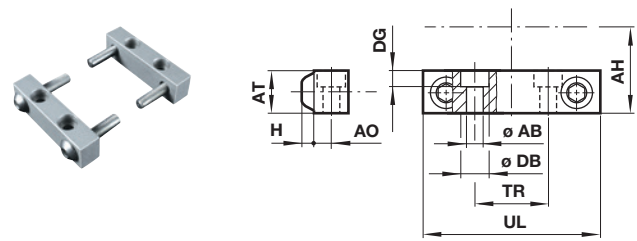
 Abmessungen in mm
 Projection/First angle

Ø	Ø AB	AH	AO	AT	H	Ø DB	DG	TR	UL	kg	Typ (C)
12	3,4	13,5	4	9,5	2	6	3,5	25	33	0,02	QM/90012/21
16	3,4	15	4	9,5	2	6	3,5	32	40	0,02	QM/90016/21
20	3,4	16,5	4	9,5	2	6	3,5	35	43	0,02	QM/90020/21
25	4,3	20	5	12,5	3	7,5	4,5	41	51	0,04	QM/90025/21
32	4,3	23	5	12,5	3	7,5	4,5	19	46	0,04	QM/90032/21
40	6,4	28,5	6,5	16	4,5	10,5	6,5	21	56	0,1	QM/90040/21
50	6,4	32	6,5	16	4,5	10,5	6,5	27	64	0,11	QM/90050/21
63	8,4	41,5	8	22	5,5	13,5	8,5	34	81	0,13	QM/90063/21
80	8,4	49	8	25,5	5,5	13,5	8,5	44	95	0,18	QM/90080/21
100	10,5	59,5	9	28,5	6,5	16,5	10,5	56	118	0,48	QM/90100/21

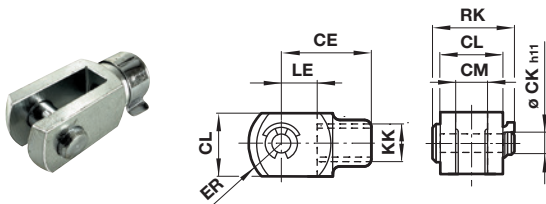
Gabelkopf – F

Ø	KK	CE	Ø CK h11	CL	CM	ER	LE	RK	kg	Typ
12	M3	11	3 h9	6	3	4,5	5	10	0,01	QM/57008/25
16	M4	16	4	8	4	6,5	8	11,5	0,01	QM/8010/25
20	M5	20	5	10	5	8	10	14,5	0,01	QM/92020/25
25	M6	20	5	10	5	8	10	14,5	0,01	QM/57016/25
32 & 40	M8	24	6	12	6	9,5	12	17,5	0,02	QM/57020/25
50	M10x1,25	26	8	14	7	11,5	12	20,5	0,04	QM/57025/25
63	M12x1,25	40	10	20	11	16	20	29	0,09	QM/57040/25
80 & 100	M16x1,5	56	14	27	14	21	28	36,5	0,22	QM/57063/25

Bolzen

Ø	A	KF	kg	Typ
12	12	M3	0,01	M/P1710/18
16	16	M4	0,01	M/P1710/19
20	20	M5	0,01	M/P1710/20
25	25	M6	0,01	M/P1710/21
32 & 40	25	M8	0,01	M/P1710/22

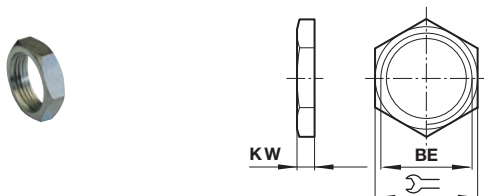
Mutter auf dem Kolbenstangenlager N

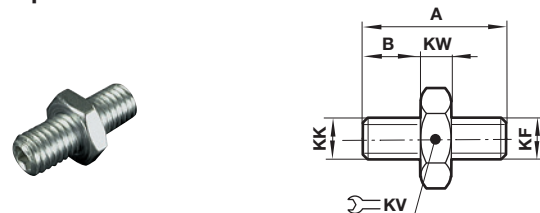

Ø	BE	KW	⌘	kg	Typ
12	M3	2	6	0,01	M/P1500/111
16	M4	2	7	0,01	M/P1501/80
20	M5	2,5	8	0,01	M/P1501/109
25	M6	3	10	0,01	M/P1501/79
32 & 40	M8	4	13	0,01	M/P1501/60

Adapter

Ø	A	B	KF	KK	⌘ KV	KW	kg	Typ
50	29	12	M10	M10x1,25	12	5	0,02	M/P71470/1
63	35	15	M12	M12x1,25	13	5	0,04	M/P71470/2
80 & 100	45	20	M16	M16x1,5	17	5	0,08	M/P71470/3

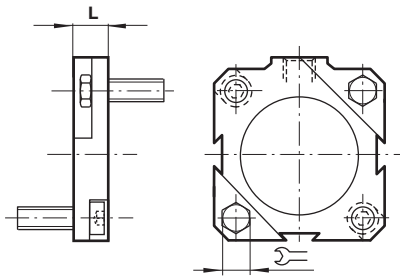
Anbausatz

 Abmessungen in mm
 Projection/First angle

Ø	L		Type
12	10	7	QM/92012/55
16	10	7	QM/92016/55
20	10	7	QM/92020/55
25	10	8	QM/92025/55
32	10	8	QM/92032/55
40	15	13	QM/92040/55
50	15	13	QM/92050/55
63	20	17	QM/92063/55
80	20	17	QM/92080/55
100	25	19	QM/92100/55

Technische Daten - Reed-Magnetschalter - weitere Information siehe Datenblatt N/de 4.3.005

Symbol	Spannung (V AC)	Spannung (V DC)	Schaltstrom max. (mA)	Funktion	Temperatur (°C)	LED	Schutzart	Stecker	Kabel- länge (m)	Anschluss- kabel	Gewicht (g)	Typ
 ± BN	10 ... 240	10 ... 170	180	Schließer	-25 ... +80	•	IP66	—	2, 5 or 10	PVC 2 x 0,25	37	M/50/LSU/*V
 ~ BU	10 ... 240	10 ... 170	180	Schließer	-25 ... +80	•	IP66	—	5	PUR 2 x 0,25	37	M/50/LSU/SU
 BN BU	10 ... 240	10 ... 170	180	Schließer	-25 ... +150	—	IP66	—	2	Silikon 2 x 0,25	37	TM/50/RAU/2S
 BK BU BN	10 ... 240	10 ... 170	180	Wechsler	-25 ... +80	—	IP66	—	5	PVC 3 x 0,25	37	M/50/RAC/5V
 + BN ~ BK	10 ... 60	10 ... 60	180	Schließer	-25 ... +80	•	IP66	M8 x 1	0,3	PVC 3 x 0,25	16	M/50/LSU/CP *1)

* Bitte Kabellänge einfügen; *1) Kabel mit Steckdose; Farbkennzeichnung: BK = schwarz, BN = braun, BU = blau

Abmessungen

M/50/LSU/*V, M/50/LSU/SU,
TM/50/RAU/2S
Kabellänge L = 2, 5 oder 10 m



M/50/RAC/5V
Kabellänge L = 5 m



M/50/LSU/CP

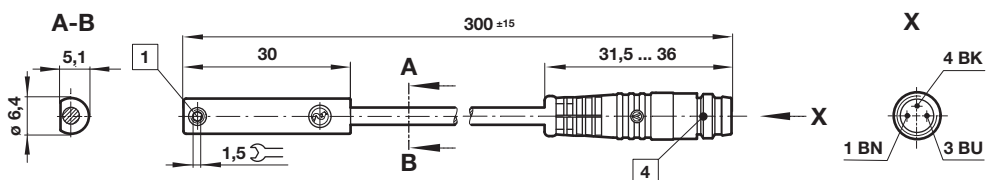
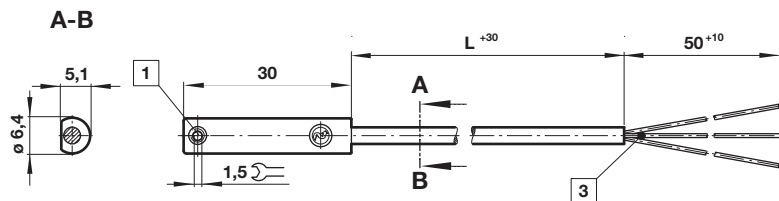
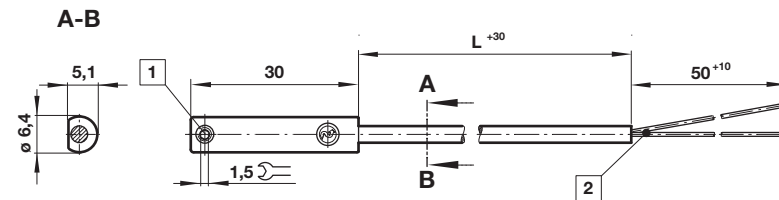

- 1 Feststellschraube
- 2 + BN = braun; - BU = blau (Ausgang)
- 3 - BK = schwarz; + BN = braun; - #BU = blau
- 4 Stecker M8 x 1, Farbkennzeichnung: BK = schwarz; BN = braun; BU = blau

Abmessungen in mm
Projection/First angle



Zubehör
Befestigung

M/P72487

Steckdose mit Kabel

Kabel	Kabellänge (m)	Gewicht (kg)	Stecker	Typ
PVC 3 x 0,25	5 m	0,18	M8 x 1	M/P73001/5
PUR 3 x 0,25	5 m	0,18	M8 x 1	M/P73002/5
PUR 3 x 0,34	5 m	0,21	M12 x 1	M/P34594/5

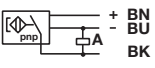
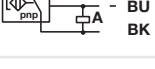
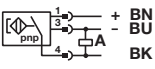
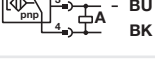
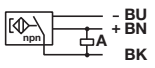
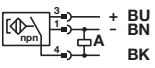
Technische Daten - elektronischer Magnetschalter - weitere Information siehe Datenblatt N/de 4.3.007

Symbol	Spannung (V DC)	Schaltstrom max. (mA)	Funktion	Temperatur (°C)	LED	Schutzart	Stecker	Kabel-länge (m)	An-schlussk-abel	Ge-wicht (g)	Typ
	10 ... 30	150	PNP	-40 ... +80	•	IP67	—	2, 5 or 10	PVC 3 x 0,12	37	M/50/EAP/*V
	10 ... 30	150	PNP	-40 ... +80	•	IP68	—	5	PUR 3 x 0,14	37	M/50/EAP/SU
	10 ... 30	150	PNP	-40 ... +80	•	IP67	M8 x 1	0,3	PVC 3 x 0,14	16	M/50/EAP/CP *1)
	10 ... 30	150	PNP	-40 ... +80	•	IP67	M12 x 1	0,3	PVC 3 x 0,14	16	M/50/EAP/CC *1)
	10 ... 30	150	NPN	-40 ... +80	•	IP67	—	2, 5 or 10	PVC 3 x 0,12	37	M/50/EAN/*V
	10 ... 30	150	Schließer	-40 ... +80	•	IP67	M8 x 1	0,3	PVC 3 x 0,14	16	M/50/EAN/CP *1)

* Bitte Kabellänge einfügen; *1) Kabel mit Steckdose; Farbkennzeichnung: BK = schwarz, BN = braun, BU = blau

Abmessungen

Abmessungen in mm
Projection/First angle



M/50/EAP/*V,
M/50/EAN/*V
Kabellänge L = 2, 5 oder 10 m

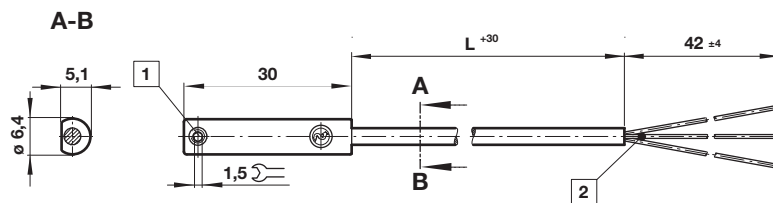

M/50/EAP/CP,
M/50/EAN/CP

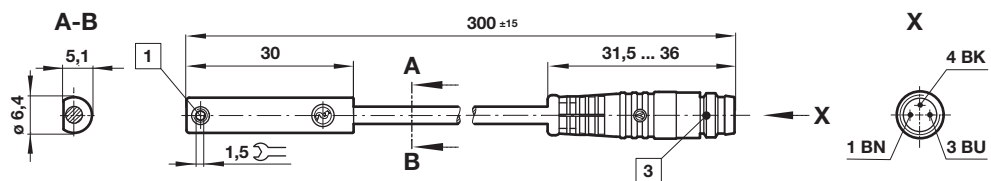

M/50/EAP/CC

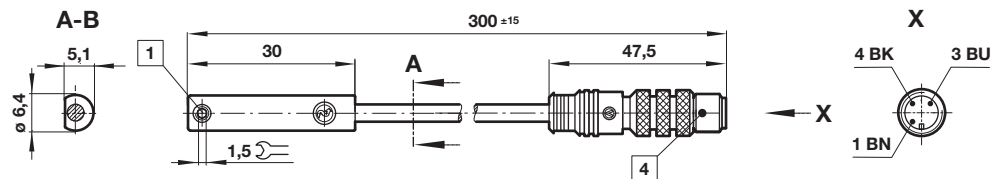

- 1 Feststellschraube
- 2 Farbkennzeichnung: BK = schwarz; BN = braun; BU = blau
- 3 Stecker M8 x 1
- 4 Stecker M12 x 1

Sicherheitshinweise

Diese Produkte sind ausschließlich in Druckluftsystemen zu verwenden. Sie sind dort einzusetzen, wo die unter »Technische Merkmale/-Daten« aufgeführten Werte nicht überschritten werden.

Berücksichtigen Sie bitte die entsprechende Katalogseite. Vor dem Einsatz der Produkte bei nicht industriellen Anwendungen, in lebenserhaltenden- oder anderen Systemen, die nicht in den veröffentlichten Anleitungsunterlagen enthalten sind, wenden Sie sich bitte direkt an IMI Precision Engineering. Durch Missbrauch, Verschleiß oder Störungen können in Pneumatik-

systemen verwendete Komponenten auf verschiedene Arten versagen.

Systemauslegern wird dringend empfohlen, die Störungsarten aller in Pneumatiksystemen verwendeten Komponententeile zu berücksichtigen und ausreichende Sicherheitsvorkehrungen zu treffen, um Verletzungen von Personen sowie Beschädigungen der Geräte im Falle einer solchen Störung zu verhindern.

Systemausleger sind verpflichtet, Sicherheitshinweise für den Endbenutzer im Betriebshandbuch zu vermerken, wenn der Störungs-schutz nicht ausreichend gewährleistet ist.